



MAX PROP®

Made in Italy - Since 1975

INSTRUCTION MANUAL

ELICA MAX PROP® EASY

AUTOMATIC FEATHERING PATENTED PROPELLER

PART ONE

MAX PROP® EASY model propeller installation, operation and maintenance instructions

1. Introduction
2. How to install the propeller on the propeller shaft
3. Checks to be carried out before launching the boat
4. Warnings for propeller use and maintenance
5. How to pull the propeller off the propeller shaft

PART TWO

Possibilities offered by your MAX PROP® EASY model

- A. The importance of propeller pitch
- B. How to change the pitch of the MAX PROP® EASY model propeller
- C. How to establish the pitch variation

PART ONE

MAX PROP® EASY MODEL PROPELLER

INSTALLATION, OPERATION AND MAINTENANCE INSTRUCTIONS

1. INTRODUCTION

Thank you for choosing a MAX PROP® feathering propeller, EASY model. This instruction manual is used to answer your questions about installing and operating the propeller. Before installing the propeller on the boat, it is essential to read it carefully.

The propeller is supplied already assembled with the optimal forward pitch and the optimal backwards pitch, based on the data provided by the customer at the time of the order, so that it can be mounted directly on the propeller shaft. Please note that the propeller does not and must not be opened.

2. HOW TO MOUNT THE PROPELLER ON THE PROPELLER SHAFT

Before proceeding with installing the propeller on the propeller shaft, check that the direction of rotation of the propeller matches the direction of rotation of your propeller shaft. Please note that in order to understand the direction of rotation of the propeller shaft, you need to look at the propeller from the stern towards the bow. If the propeller shaft turns clockwise when shifting into forward gear, the rotation is right-handed. On the contrary, if the propeller shaft turns counter-clockwise when shifting into forward gear, the rotation is left-handed.

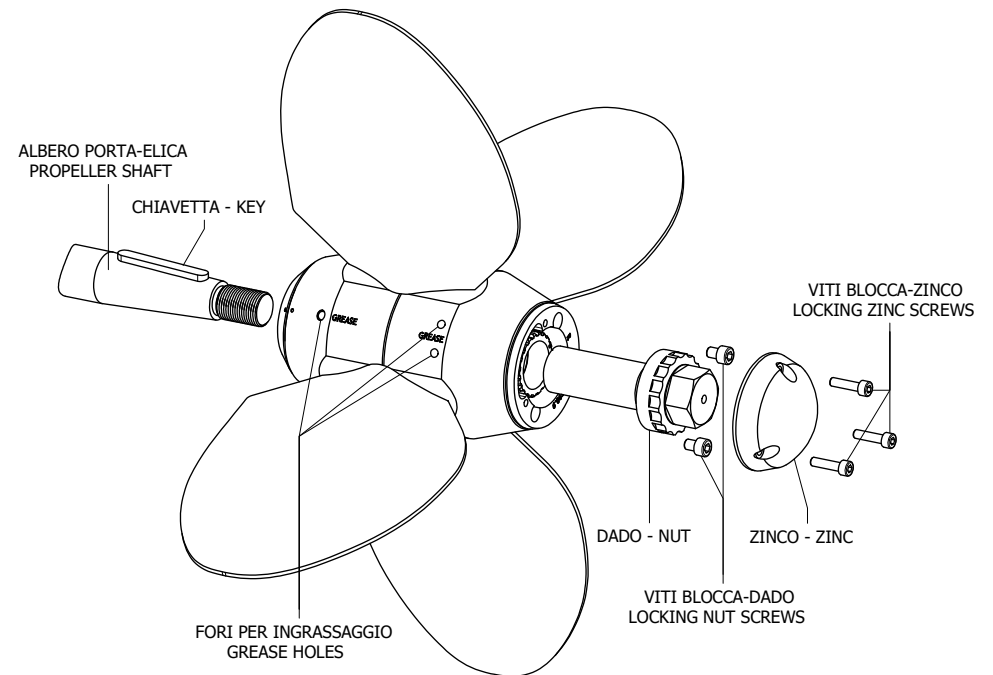

fig. 1

Please carry out the various operations by referring to fig. 1.

- a. Fit the already assembled propeller on the propeller shaft.
- b. Verify that the key is of the appropriate size, i.e. that it has clearance on the upper surface (to avoid the propeller from being brought off-centre) and that it has no clearance between the side surfaces. In order to verify this, we suggest inserting the propeller on the propeller shaft without mounting the key and marking with a bit the precise position at which the propeller hub locks onto the tapered shaft. Then extract the propeller and mount it again after inserting the key in its seat on the propeller shaft. If the hub reaches the same position as before, the key height is correct. Otherwise, the thickness of the key must be reduced so that the hub can penetrate to the position previously marked.

- c. Insert the nut into its seat, screw it in and lock it by using the two locking nut screws that must be inserted in their seats and then tighten. The nut tightening torque must not be too high (approximately 20/30 Newton/meter for propeller shafts smaller than 35 mm and approximately 30/40 Newton/meter for propeller shafts larger than 35 mm). This is to prevent (in the event of any irregularities in the machining of the propeller shaft) the shank and the head of the nut from being forced and jammed inside their seat, thus making it difficult to unscrew when the propeller is removed. To ensure that the above does not occur, it is recommended (after screwing the nut to abutment and before inserting the two locking nut screws) to unscrew the nut a few turns in order to ensure that it rotates freely in both the screwing and unscrewing directions. Then return the nut to the abutment position and secure it with the two locking nut screws.
- d. Check that the propeller body is completely filled with fluid grease and if it is not, proceed as indicated in paragraph 4.d

3. CHECKS TO BE CARRIED OUT BEFORE LAUNCHING THE BOAT

- a. Check that the propeller body rotates freely around the same shaft, so that the blades can move freely from the forward position to the reverse position and vice versa. To verify this, rotate the propeller body while keeping the rotation of the propeller shaft fixed, or vice versa, rotate the propeller shaft while keeping the rotation of the propeller body fixed. It is important that the blades are not grabbed and forced with your hands. The blades must be left completely free to rotate on their own around their axes. It is therefore advisable to carry out this check without touching the blades. At most, if the rotation of the propeller shaft is kept still, the blades can be pushed with a finger or the palm of an open hand. We point out that when the propeller is installed on the propeller shaft it is wrong (and impossible) to rotate the propeller blades by grabbing and pushing them with your hands.
- b. Check that the propeller is full of very fluid grease and that the grease seeps out of the propeller. If this is not the case, proceed as indicated in paragraph 4.d.
- c. Ensure protection of the propeller against galvanic corrosion by applying appropriate zinc anodes which must be in electrical contact with the bronze.

4. WARNINGS FOR THE USE AND MAINTENANCE OF THE PROPELLER

- a. The reverse gear must always be engaged starting from the forward gear position. Therefore, before engaging the reverse gear, the forward gear must be engaged for a moment.
- b. In order to have the propeller blades feathered, the rotation of the propeller shaft must be blocked, even for a few seconds, while the boat moves forward with a speed of at least 5-6 knots and the propeller blades are arranged in the forward position (in the case of mechanical transmission just stop the engine while leaving the forward gear engaged). To check whether the propeller blades have actually reached the feathered position, simply let the propeller shaft rotate freely again by switching the gear to neutral. If the propeller shaft starts rotating, it means that the blades are not feathered and it is therefore advisable to repeat the operation.
- c. When the boat is sailing with the engine off, it is advised to leave the propeller shaft free to rotate by switching the gear to neutral. It is important not to sail with the gear engaged. This rule must be respected especially with fast boats, such as catamarans.
- d. Fill the propeller body completely with fluid grease through the designated holes marked "grease" (see fig. 2).

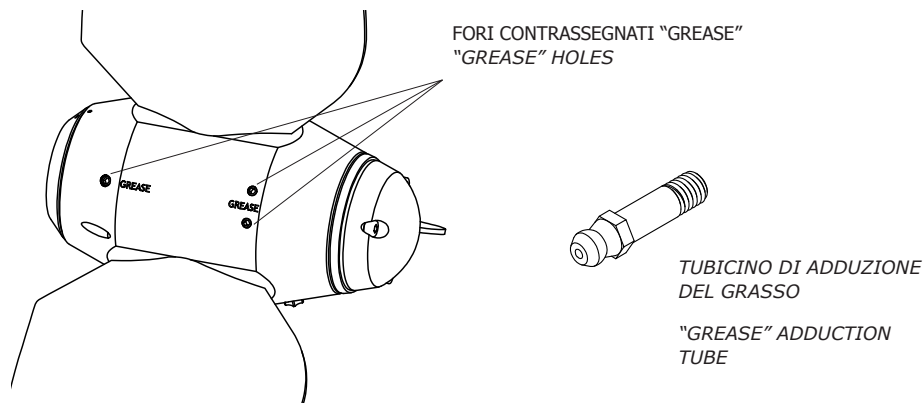

fig. 2

- Start with a first hole of your choice
 - Remove the locking threaded grub screw from the hole.
 - Screw the grease inlet tube into the hole (the tube is supplied with the propeller). Start injecting grease into the propeller body by applying pressure. Keep the injection pressure applied until the injected grease begins to seep out of the propeller body both through its joints and the surfaces of the elements which, during operation, must rotate with respect to the propeller body (blades and hub). At this point the sector relating to the first hole is full of grease.
 - Remove the grease inlet tube and close the hole by re-tightening the locking grub screw.
 - Repeat the same operation on each of the other holes marked "grease" so as to ensure that each sector of the propeller body inside is completely filled with grease.
 - The grease must be fluid and must drip to ensure that, even without the thrust of the grease pump, it will keep seeping from the propeller body, ensuring the lubricating effect on the surfaces that must rotate relatively to one another.
- e. During motor navigation, bear in mind that if the engine is turbocharged and is run at low RPM for a long time, the turbine tends to get dirty. It may happen that when accelerating, the engine will not be able to pick up all the revolutions. This drawback is due solely to the engine and not to an excessive propeller pitch. To avoid this it is necessary, every two hours or so, to put the engine in neutral and let it reach maximum RPM for a few seconds. This procedure is expressly suggested by all marine engine manufacturers.
 - f. Protect the propeller against galvanic corrosion by applying a sufficient mass of zinc. Replace the zinc anodes on average once a year, even if they have not corroded and check that there is good electrical contact between the zinc, the bronze of the propeller and the propeller shaft. If the contact surfaces between zinc and bronze are encrusted, it is advisable to clean them by using an abrasive cloth.

5. HOW TO PULL THE PROPELLER OFF THE PROPELLER SHAFT

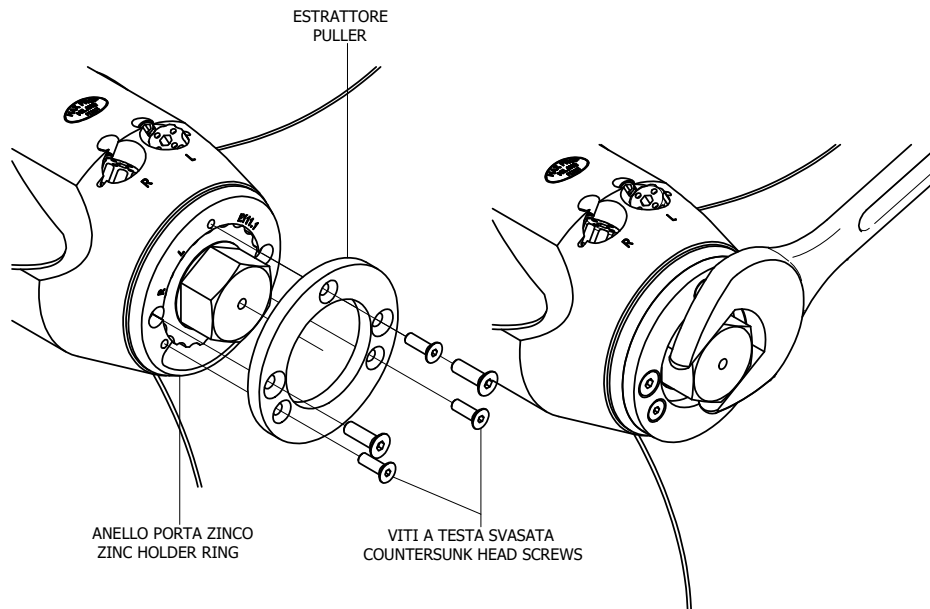

fig. 3

Please proceed by referring to fig. 3:

- a. Remove the zinc.
- b. Remove the two locking nut screws.
- c. Please check that the nut is free to come loose and check which direction of rotation causes the unscrewing of the nut (in most cases, the nut will unscrew if it is rotated counter-clockwise).
- d. Screw the nut back in until it is moved again to abutment against the propeller.
- e. Fasten the puller (consisting of a perforated washer) to the zinc-holding ring by using special countersunk head screws.
- f. In each threaded hole of the zinc-holding ring, a countersunk head screw for locking the puller must be inserted. Check that all screws work together to hold the puller pressed against the zinc-holding ring. To do this, the longer countersunk head screws must be screwed into the holes where the locking nut screws were housed, whereas the shorter countersunk screws must be screwed into the holes where the locking zinc screws were housed.
- g. It is very important to check that each countersunk head screw for locking the puller, is neither too long nor too short. Each screw must be tightened into its own threaded hole for a length not less than its own diameter. The same screw, when fully screwed (and tightened against the puller) must **NOT** touch the bottom of its threaded hole.
- h. Gently unscrew the nut, ensuring that all countersunk head screws work together to bear the load necessary for pull the propeller out. That is, all countersunk head screws hold the puller pressed against the zinc-holding ring.
- i. Gradually increase the nut unscrewing torque. It is recommended not to exceed 100-200 Newton/metre (which corresponds to a load of 10-20 kg on a lever that is one metre long) and to apply the unscrewing force with pauses in between.
- j. After each pause and before reapplying the load for unscrewing the nut, it is important to check that all countersunk head screws for securing the puller have not loosened. In the event of loosening, each screw must be re-tightened against the puller.
- k. When the unscrewing of the nut has tensioned all screws, use a plastic mallet to tap the propeller body. These taps will cause the propeller hub to detach from the propeller shaft.

PART TWO

POSSIBILITIES OFFERED BY YOUR MAX PROP® EASY MODEL

A. THE IMPORTANCE OF THE PROPELLER PITCH

As is known, the function of the propeller is to transform the power supplied by the engine into thrust for the boat. The most important parameter, which determines the level of propeller performance, is the pitch. In fact, even small changes in pitch involve changes in the navigation speed. The second important parameter is the diameter which, however, has less influence than the pitch. In fact, a small change in the propeller diameter, with the same pitch, does not involve any change in the navigation speed. All the other characteristics of the propeller have negligible influence compared to the pitch and diameter.

The MAX PROP® EASY model propeller is supplied with the two optimal pitches already set based on the requests and the data provided by the customer at the time of ordering. In any case, an innovative device patented by Max Prop® offers, if the user so wishes, the possibility of easily and precisely varying the forward pitch and the reverse pitch, independent of each other.

For convenience, all propeller pitches are “improperly” expressed in degrees. In the table (fig. 4), for some propeller diameters, the theoretical pitches in millimeters corresponding to the different blade inclination angles α are shown.

		Diametro dell'Elica (millimetri)											
		300	350	400	450	500	550	600	650	700	750	800	
α	Angolo di inclinazione pale (gradi)	10°	100	115	130	150	170	185	200	215	230	250	265
	12°	120	140	160	180	200	220	240	260	280	300	320	
	14°	140	165	190	210	235	260	280	305	330	350	375	
	16°	160	190	215	245	270	300	325	350	380	405	430	
	18°	180	215	245	275	305	335	365	400	430	460	490	
	20°	205	240	275	310	345	375	410	445	480	515	550	
	22°	230	265	305	340	380	420	455	495	535	570	610	
	24°	250	295	335	375	420	460	505	554	585	630	670	
	26°	275	320	370	415	460	505	550	590	645	690	735	
	28°	300	350	400	450	500	550	600	650	700	750	800	
30°	325	380	435	490	545	600	655	705	760	815	870		

fig. 4

B. HOW TO CHANGE THE PITCH OF THE MAX PROP® EASY/WHISPER MODEL PROPELLER

Two screws/rods are inserted in the body of MAX PROP® EASY model propeller. A screw/rod is used to adjust the change in forward gear pitch. A screw/rod is used to adjust the change in the reverse gear pitch. Each of the two pitches is changed by simply varying the depth of penetration into the propeller body of the respective screw/rod.

Eight grooves are carved in the head of each screw/rod for housing the locking grub screw (see fig. 5 and 6). This grub screw must be removed before starting the pitch change operation and must be reinserted when the operation is completed.

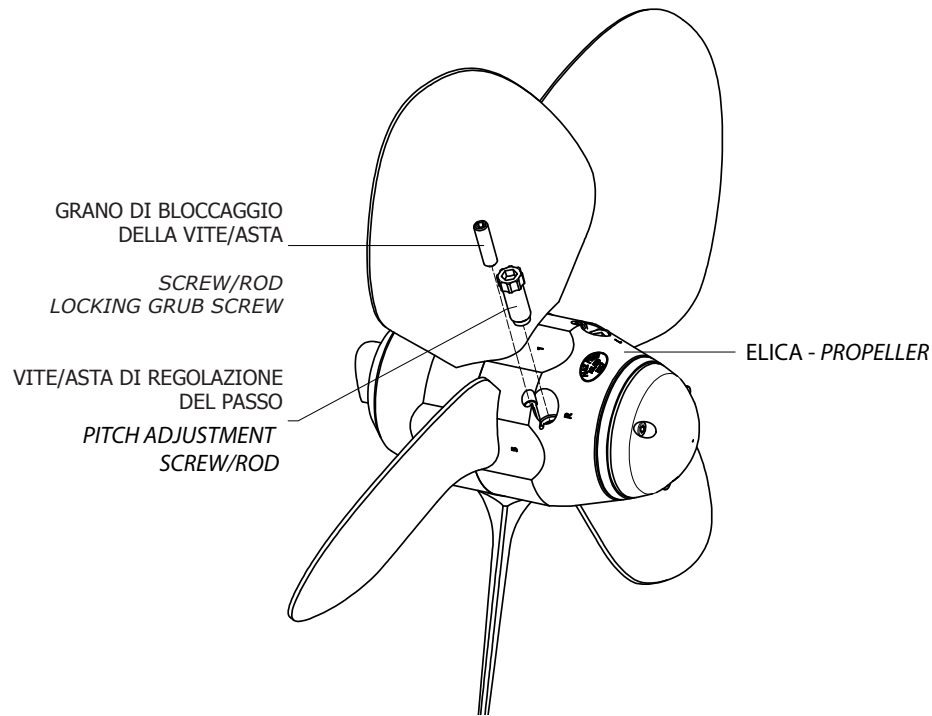

fig. 5

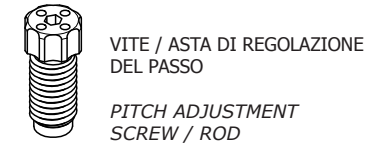
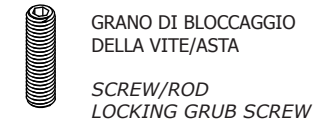
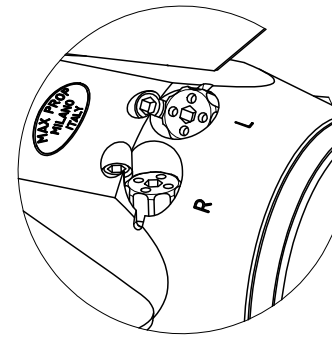

fig. 6

FORWARD

If the propeller is right-handed, the forward gear pitch is changed by operating on the screw/rod inserted in the threaded hole "R" (right). If the propeller is left-handed, the forward gear pitch is changed by operating on the screw/rod inserted in the threaded hole "L" (left). *In case of doubts in understanding the direction of rotation of the propeller shaft, see section G.*

The forward gear pitch increases if the depth of penetration into the propeller body of the respective screw/rod is increased. On the contrary, the forward gear pitch decreases if the depth of penetration into the propeller body of the respective screw/rod is decreased.

If the screw/rod, already inserted and set in its seat, is rotated clockwise by an angle of 45° (which corresponds to a gap between two adjacent grooves formed on the head of each screw/rod), the forward gear pitch will increase by half a degree (0.5°). Conversely, if the screw/rod, already inserted and set in its seat, is rotated counter-clockwise by an angle of 45°, the forward gear pitch will decrease by half a degree (0.5°).

FORWARD

If the propeller is right-handed, the reverse gear pitch is changed by operating on the screw/rod inserted in the threaded hole "L" (left). If the propeller is left-handed, the reverse gear pitch is changed by operating on the screw/rod inserted in the threaded hole "R" (right). *In case of doubts in understanding the direction of rotation of the propeller shaft, see section G.*

The reverse gear pitch increases if the depth of penetration into the propeller body of the respective screw/rod is decreased. On the contrary, the reverse gear pitch decreases if the depth of penetration into the propeller body of the respective screw/rod is increased.

If the screw/rod, already inserted and set in its seat, is rotated clockwise by an angle of 45° (which corresponds to a gap between two adjacent grooves formed on the head of each screw/rod), then the reverse gear pitch will decrease by half a degree (0.5°). Conversely, if the screw/rod, already inserted and set in its seat, is rotated counter-clockwise by an angle of 45° , the reverse gear pitch will increase by half a degree (0.5°).

C. HOW TO ESTABLISH THE PACE VARIATION

In most cases it is not important to know the absolute value of the forward pitch and the reverse pitch already set, it is instead important to establish the possible variation you may wish to make.

If the engine does not reach the maximum RPM desired by the customer, the pitch must be decreased, if, on the contrary, the engine exceeds the maximum RPM desired by the customer, the pitch must be increased.

If the pitch is increased by 0,5 degree, the boat speed, at the same engine RPM, will increase by about 2,5%. Conversely, if the pitch is decreased by 0,5 degree, the boat speed, at the same engine RPM, will decrease by about 2,5%.

Or, if the pitch is increased by 0,5 degree, the engine RPM, at the same boat speed, will decrease by about 2,5%. Conversely, if the pitch is decreased by 0,5 degree, the engine RPM, at the same boat speed, will increase by about 2,5%.

The Max Prop® propellers are supplied with two screws/rods each marked with a two-digit number "N".

The screw/rod housed in the forward hole allows you to set any forward pitch between 10 degrees and "N" degrees.

The screw/rod housed in the reverse hole allows you to set any reverse pitch between 30 degrees and (40 - "N") degrees.

GENERAL SALES TERMS AND CONDITIONS FOR MAX PROP® PROPELLERS

1. These general sales terms and conditions apply to all Max Prop propellers' sales agreements and to all relations arising out of, inherent in or, in any way, consequent to them.
2. As soon as the goods are ready, Max Prop s.r.l. gives notice to the customer who must take care of the collection.
 - 2.1. Place of delivery, with consequent transfer of all liabilities and risks to the purchaser, is seller's Ex-Works (EXW) at the workshop of Max Prop s.r.l. located in Milan, at Viale Carlo Espinasse no. 101, and the goods will always travel under the responsibility of the purchaser, at their own risk. Therefore, by delivering the goods to the carrier, Max Prop s.r.l. cannot be held in any way responsible for any damage that may occur due to loading, mislaying, theft, damage, loss or delay in the delivery of the goods.
 - 2.2. At the customer's request, if Max Prop s.r.l. ships the goods via the carrier, which must in any case be indicated by the customer, it shall always act on behalf of the customer, and the customer shall be responsible for any inherent and consequent liability due to transport. In this case, the cost of the goods will include the shipping cost. This cost never comprises any kind of transport risk insurance. In the event that the customer wishes to insure the goods, the customer shall take care of this, at its own expense. In the event of mislaying, theft, damage, loss of the goods during transport or in the event of delayed delivery, the purchaser may exclusively take action against the forwarding agent and/or the carrier appointed, with express exemption of Max Prop s.r.l. from any related liability.
3. The propellers sold by Max Prop s.r.l. are warranted for a period of 12 (twelve) months from delivery. Any defects found by the customer must be reported, under penalty of voiding the warranty, within and no later than 8 (eight) days from delivery by means of a written communication. The repair or replacement of the goods under warranty, as set out at point 5 below, does not extend the warranty validity period, which remains set at 12 (twelve) months from the first delivery of the goods.
4. The warranty does not cover parts subject to wear and tear and damages resulting from improper use of the goods, as well as all cases in which the defect is due to any cause other than and not related to manufacturing. The goods under warranty must not be subjected by the customer to any repair work on their own or by third parties, unless expressly authorised and agreed with Max Prop s.r.l., under penalty, at fault, of exclusion and voiding of the warranty.
 - 4.1. The components of each propeller must not be modified by the customer in any way and for any reason.
 - 4.2. The components of each single propeller, none excluded, are not interchangeable between one propeller and the other.
 - 4.3. The propeller must be used in strict accordance with the instructions provided in the manual, paying particular attention to the warnings.
 - 4.4. Failure to comply with points 4.1, 4.2 and 4.3 shall result in the exclusion and voiding of the warranty.
 - 4.5. Likewise, the warranty is void if the defect has nevertheless occurred due to the customer's failure to comply with the requirements regarding the assembly, operation and maintenance of the item as set out in the instruction manual.
5. In the event that the goods are recognised by Max Prop s.r.l. as actually different or flawed due to manufacturing or material defects, the customer will only be entitled to repair or replacement of the original propeller parts free of charge. The warranty is therefore limited solely and exclusively to the repair or replacement of the faulty propeller free of charge, with the express exclusion of any other liability of Max Prop srl for any direct, indirect, financial and non-financial damages (none excluded) to property or persons. Max Prop srl will not, under any circumstances and for any reason whatsoever, pay any indemnity, compensation and/or refund of any kind, not even in part. This warranty replaces and excludes all other warranties, expressed or implied, that are required by law.
6. In the case referred to in the previous point, any repairs under warranty will be carried out by Max Prop s.r.l. at its workshop located in Milan, at Viale Carlo Espinasse no. 101. The customer will be responsible for sending the propeller intact and complete with all its parts to this workshop. Until the receipt of the goods by Max Prop s.r.l., the risk of mislaying, theft, damage, loss of the goods or delay in delivery lies entirely with the customer. Once the goods have been received, Max Prop s.r.l., having verified the actual existence of the defect and the absence of causes for the exclusion of the warranty, will decide at its sole discretion whether or not to proceed with a repair or replacement of the propeller.
7. These general sales terms and conditions are integral and substantial part of any purchase agreement stipulated with Max Prop srl.
8. These general sales terms and conditions and related sales agreements are governed by the Italian law. Any disputes arising out of, relating to or in any way resulting from this agreement, its interpretation, application and performance shall fall under the exclusive jurisdiction of the Court of Milan, to the exclusion of any other court.
9. The official and binding text of these general sales terms and conditions is only that which is written in Italian. Any translations into other languages are merely a matter of courtesy. It is therefore established that, in case of any divergence, only the Italian text will have value to any effect of law.
10. The purchaser acknowledges and agrees that the sale price of the propeller has also been determined in consideration of the acceptance by the purchaser of these general sales terms and conditions. By accepting this agreement, the purchaser excludes and in any case waives any kind of exception, dispute, request and/or claim.

NOTES

A series of horizontal dashed lines for writing notes, arranged in two columns.

090624



manufactured by: MAX PROP®
viale Carlo Espinasse, 101 - 20156 Milano - ITALY
tel. +39 02 33 404 325 - skype: maxprop1
www.maxprop.it - info@maxprop.it

